









# Luminaria Alumbrado Público LED

## Monzon



### 50-100-150W

Línea de alumbrado público LED de alto desempeño lumínico y diseños especiales para áreas de alto tráfico y exposición a las inclemencias del clima.

-  Diversas distribuciones lumínicas
-  Dimensiones reducidas
-  Único color de cuerpo
-  Compacto
-  Montaje vertical
-  Tecnología LED
-  Bajo impacto ambiental
-  Único color de luz

**Vida útil**  
50.000Hrs

- SEC
- RoHS
- IP66
- CRI 70



## Especificaciones técnicas

**Temperatura de color** 5.000°K  
**Ángulo de apertura** T II Med  
**Material cuerpo** Aluminio y policarbonato  
**Tipo de LED** SMD 2835  
**Input** 120-277 VAC  
**Eficacia** >110lm/W  
**Fáctor de Potencia** >0.97  
**THD** <0,8%  
**Altura de montaje** Min 2,5mt Máx 18mt  
**Posición de uso** Universal / Horizontal  
**Ip** 66

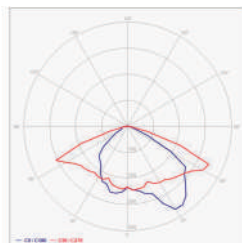
## Diagrama de distribución



### FINALIDAD DEL PRODUCTO

-  Exterior
-  Iluminación de áreas calles y autopistas
-  Fijación a poste, par de apriete 8 NM







## Driver



### Corriente Constante

**F.P.** >0.97  
**THD** ≤0,8  
**Frecuencia** 50/60Hz

### CARACTERÍSTICAS FÍSICAS

-  Gran distribución luminosa
-  Carcasa hermética IP66.
-  Ambiente de funcionamiento: temperatura entre -30°C a +70°C y humedad 10% a 95%.
-  Producto certificado según PE N° PE5/07
-  Pintura electrostática.
-  Accesorios de acero inoxidable y galvanizados en caliente

## Medidas

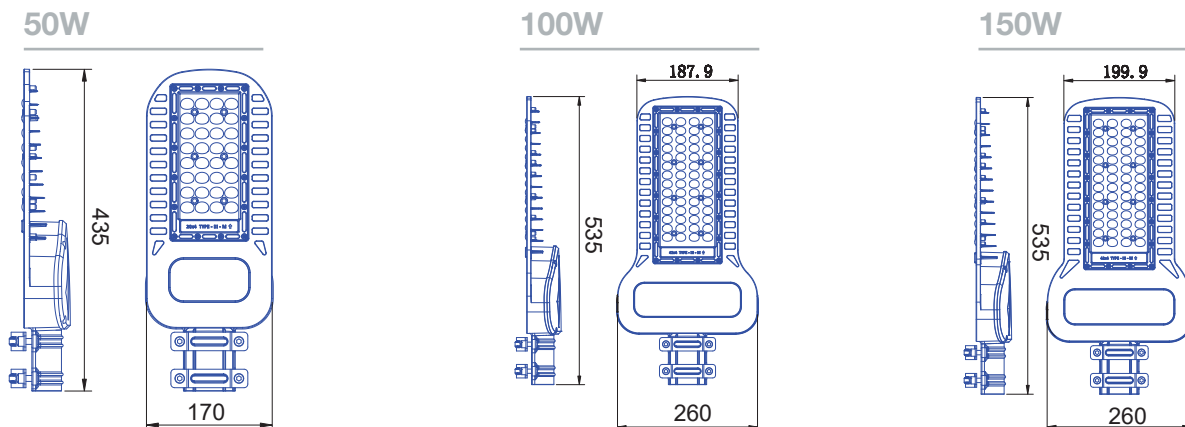

Modelo	Potencia (W)	Dimensiones (mm)	Peso (Kg)	Voltaje de entrada (Vac)	Frecuencia (Hz)	Código	Corriente (A)
MONZON	50	435x170x63	1,6	90-305V	50 / 60Hz	20900050	0,22A
MONZON	100	535x260x64	2,4	90-305V	50 / 60Hz	20900100	0,47A
MONZON	150	535x260x64	2,8	90-305V	50 / 60Hz	20900150	0,68A

